

Byron™ Extra Loud Wire Free Chime Kit

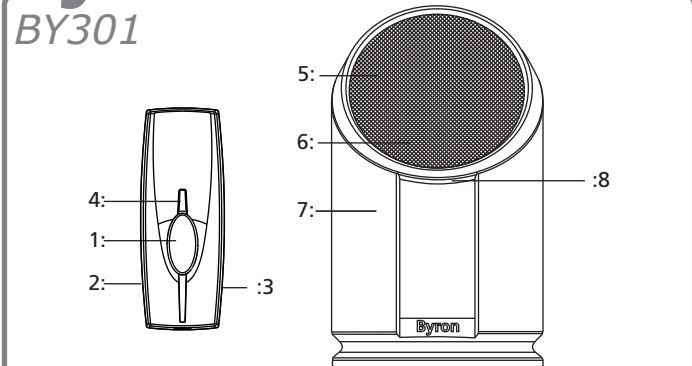

- 1: Push Button
- 2: Melody Selector
- 3: Bell Push Battery
- 4: Signal Sent LED
- 5: Portable Chime
- 6: Speaker
- 7: Volume Control
- 8: Strobe Alert

Setup:

1

- Place a small flat screwdriver into the locking clip on the base of the Bell Push.
- Gently twist.
- The backing plate will unclip.

2

- Insert CR2032 battery (Supplied) into the battery holder.
- Make sure the positive side is facing upwards.
- Replace back plate.

Warning: Make sure that the batteries are replaced correctly to avoid battery failure. Only replace with same or equivalent type.

3

- Remove the battery cover.
- Insert 3 X 1.5V Size 'C' batteries (Not Supplied).
- Make sure the Positive/Negative terminals match the internal markings.
- Chime will 'Beep' on Start up.
- Replace the battery cover.

4

Hold For 6 Sec **Beep Beep** **Within 60 Sec**

- Press and hold the 'VOL' button on the Door Chime, until the Chime goes 'Beep Beep' (6 Seconds).
- Press the Bell Push within 60 seconds to learn the Bell Push to the chime.
- The Chime will ring to confirm setup.

Note: Maximum of 6 Bell Pushes can be learnt to a single Chime.

Functions:

Melody Selection:

- Remove the Back Plate from the Bell Push.
- Press the Melody Select button.
- The chime will play the newly selected sound.
- Press again to select the next melody.

Note: For Front/Back door setup, select a different melody in one of the Bell Pushes.

8 Selectable Melodies

1: Tubular 3-Note	5: Tubular Score
2: Big Ben	6: Clarinet
3: Tubular 2-Note	7: Saxophone
4: Solo	8: Morning Dew

Volume Control:

To select the Chime Volume level, press the 'VOL' button on the chime. There are 4 selectable volume levels, the Door Chime is pre-set to the loudest volume setting.

LED Flash Alert:

FLASH: Button
Press to switch the LED Alert On or Off

FLASH: ON
LED Light will flash

FLASH: OFF
Chime will 'Beep'

Adding Additional Chime/Bell Push:

Hold For 6 Sec **Beep Beep** **Within 60 Sec**

- Press and hold the 'VOL' button on your New Door Chime, until the Chime goes 'Beep Beep' (6 Seconds)
- Press the Bell Push within 60 seconds to learn the additional Chime to the Bell Push.
- Chime will ring to confirm setup, wait 60 seconds for the Chime to exit the learn mode before reprassing the bell push.

Additional Chime

To add an additional Chime unit to the Door Chime kit

- Press and hold the 'VOL' button on your New Door Chime, until the Chime goes 'Beep Beep' (6 Seconds)
- Press the Bell Push within 60 seconds to learn the additional Chime to the Bell Push.
- Chime will ring to confirm setup, wait 60 seconds for the Chime to exit the learn mode before reprassing the bell push.

Additional Bell Push

To add an additional Bell Push to the Door Chime kit.

- Press and hold the 'VOL' button on your Door Chime, until the Chime goes 'Beep Beep' (6 Seconds).
- Press the Bell Push within 60 seconds to learn the additional Bell Push to the Chime.
- Chime will ring to confirm setup, wait 60 seconds for the Chime to exit the learn mode before reprassing the bell push. For Front/back door setup, select a different melody in one of the Bell Pushes - See Melody Selection.

Front Door **Back Door**

1: Front Door Bell Push, 2: Back Door Bell Push, 3: Bell Push, 4: Bell Push, 5: Bell Push, 6: Bell Push

Note: Maximum of 6 Bell Pushes can be learnt to a single Chime

Installation Guide:

1  **Avoid** locating the Bell Push/Chime on or directly near metallic surfaces as this may reduce the operation range.
UPVC Door Frames:
 When locating the bell push onto a UPVC door, always check the operating performance before final installation, internal metal frame may affect performance.
Tip: Try adjusting the location of the Bell Push to the Left/Right or place on external wall.

Installation Guide: Bell Push

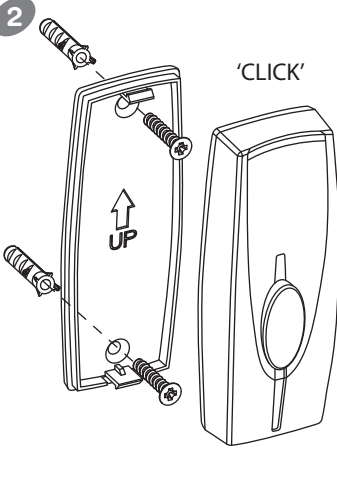
2  'CLICK'

- Using back plate as a template.
- Making sure UP arrows points UP.
- Mark and drill holes.
- Insert wall plugs and attach to wall using screws provided.
- Clip the Bell Push on to the back plate making sure the Bell Push 'Clicks' in to place.

Tip: The Bell Push can be installed using a suitable double sided adhesive tab or tape when drilling is not suitable.

Changing Batteries:

1 x 3V CR2032

Bell Push:

- Remove back plate from the Bell Push.
- Remove old battery from the holder.
- Replace with new 'CR2032' 3V battery.
- Insert into holder making sure '+' is facing up.
- Test Chime Kit.

Chime Unit

- Remove Batteries.
- Insert new batteries, 3 X 1.5V size 'C'.
- Make sure Positive/Negative match the internal markings.
- Chime will 'Beep' on start up.
- Test Chime Kit.

3 x 1.5V 'C' *Always dispose of old batteries in an environmentally friendly way.*

Resetting Chime:

Vol **2:**  **Hold For 6 Sec**

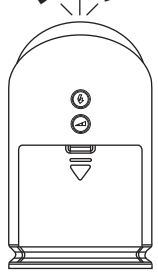
3:  **Beep Beep**

4:  **Hold For 6 Sec**

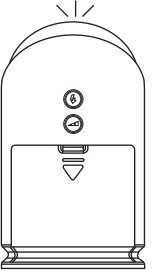
4:  **Beep**

Reset Chime unit to factory settings.

- Press and hold the 'VOL' button on your Door Chime, until the Chime goes 'Beep Beep' (6 Seconds)
- Release the 'VOL' button
- Re-press and hold the 'VOL' button on your Door Chime, until the Chime goes 'Beep' (6 Seconds)
- The Chime is now reset.

Installation Guide: Chime

3 Place the door Chime within the operating range, transmission of the wire free signal through Walls, Doors and Ceilings etc, may reduce the operating range. Chime unit for INDOOR use only.

Range Guide

High

1

2

3

4



Low



Diagram for illustration purposes only

Type R2 Device - device where the sound output is created by the initial operation of the control and where the period of sound output continues for the designed duration irrespective of condition of the control.

IMPORTANT: There are no serviceable parts, do not repair.

Specification

IP44   **Bell Push: BYT**
 Power: 1 x CR2032 3V DC Battery (Included)
 IP44 Weather Resistant

  **Portable Door Chime: BY301**
 Power: 3 x C/LR14 1.5V Batteries (Not supplied)
 Range: 100 Metres
 Indoor Use Only



 **Tel: 0845 2301231 (UK)**
 9-5 Mon-Fri, Local call charges apply

 **support@chbyron.com**

 **http://www.chbyron.com**

 **GB: CH Byron**
 Byron House, Sherwood Rd
 Astonfields, Bromsgrove
 B60 3DR
 UK

Byron 433.92MHz

R&TTE APPROVED 

A	A	IRL	A	UK	A	M	A
B	A	I	A	BG	A	N	A
DK	A	L	A	CZ	A	SK	A
FIN	A	NL	A	EST	A	SLO	A
D	A	P	A	H	A	CH	A
GR	A	E	A	IS	A	PL	A
LT	A	S	A	LV	A	RO	A

CH Byron Electrical United Kingdom. www.chbyron.com

V1.0 Project Manager Mr G Hunter 