

Amplified Telephone with Voice Synthesis and Emergency Call

English



NOTE: This phone may be for people with hearing problems. It has a variable volume headset. On first use, make sure that the headset volume is set to minimum. The hearing impaired may subsequently increase the volume to suit their needs.

Prior To Use	4
- Congratulations	4
- Safety Precautions	5
- Setting Up	6
- Location Of Controls	7
- Keys Description	9
- LCD Description	10
- Night Light Function	11
- Wall Mounting	12
Basic Functions	13
- Making a Call	13
- Receiving a Call	14
- Muting the Microphone	15
- Using the Amplification Function	15
- Using you Phone with hearing aids	15
- Using the Headset jack	16
- Hands-free	16
- Hold Function	16
- Ringer Setting	17
- One-touch Memory	18
- Flash Signal	20
- Caller ID	20
- Phone Book	22
Menu Functions	25
- Menu Navigation	25
- Menu Map	25

Contents

- Set Display 26
- Set Phone 28
- Setting Date & Time 30
- Set Talk 31
- SOS Setting 33

- Caller ID on Call Waiting 37**

- Feature List 38**

- Troubleshooting 39**

- SAFETY INFORMATION 40**

- GUARANTEE 41**

- RECYCLING DIRECTIVES 42**

Congratulations

on purchasing our high quality product.

Please read the manual carefully to find out all features and how your telephone works, so you can get the best out of your new phone.



Safety Precautions

To reduce the risk of electrical shock and injury, please follow these basic safety precautions before using the phone :

1. Carefully read and observe the instructions in this manual.
2. The phone is capable of amplifying sounds to a loud volume. It is important to instruct all potential users of its proper operation. It is advised to adjust the volume control to its minimum level (Low) when not in use and alert other users that hearing damage can potentially result from misuse.
3. When cleaning, unplug the phone first, then use a damp cloth to wipe. Do not use liquid or aerosol cleaners.
4. Do not place objects on the line cord that may cause damage.
5. Do not use this phone in wet surroundings or environments where there is a risk of explosion.
6. Unplug this phone from the wall outlet and refer servicing to qualified service personnel only.
7. Use only **the power supply indicated in the User's Manual.**
8. Do not place anything on the power cord. Install the telephone where no one will step or trip on the cord.
9. Do not overload wall outlets or extension cords as this can increase the risk of fire or electrical shock.
10. Never push any objects through the slots in the telephone. They can touch dangerous voltage points or short out parts that could result in a risk of fire or electrical shock.
11. Never spill liquid of any kind on the telephone.
12. Keep the phone out of the reach of children.
13. Use the phone only in the described manner.
14. Stop using the phone if it becomes damaged.

Setting Up

CHECK THE CONTENTS OF THE BOX

Box should contain :

- Handset with handset cord and phone base
- Telephone line cord
- User's manual
- Remote for emergency call
- Adapter (7.5V)

CHOOSING A LOCATION

The unit should be located in an area where it is easy to see the visual display and lighted ringer.

Choose a location that is out of the way of normal activities.

ADAPTER INSTALLATION

You can also insert the adapter for the LCD display, and you must insert the adapter for LCD back light and other special functions, please refer to the concrete requirement in the manual.

CAUTION: Always connect the AC adapter to the phone before you connect it to the AC power. When you finish, disconnect the AC power before you disconnect it from the telephone.

CONNECTING LINE CORDS

Plug one end of the supplied modular cord into the line jack. Then plug the other end into telephone line jack.

Note:

You can also use the phone to make or receive a call without inserting an adapter.

Location Of Controls

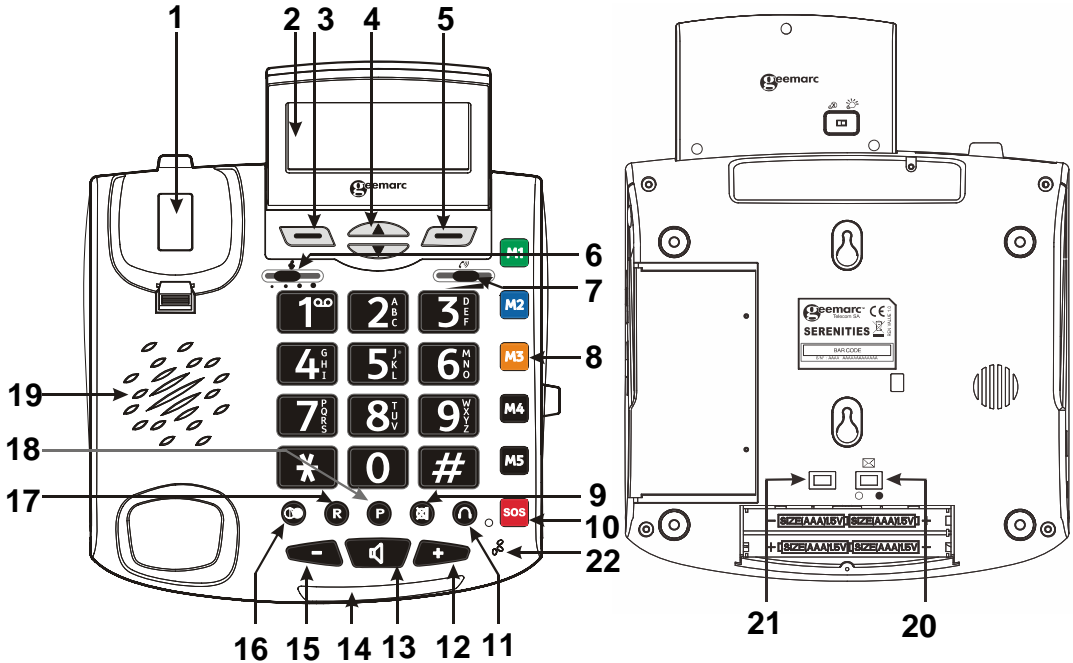



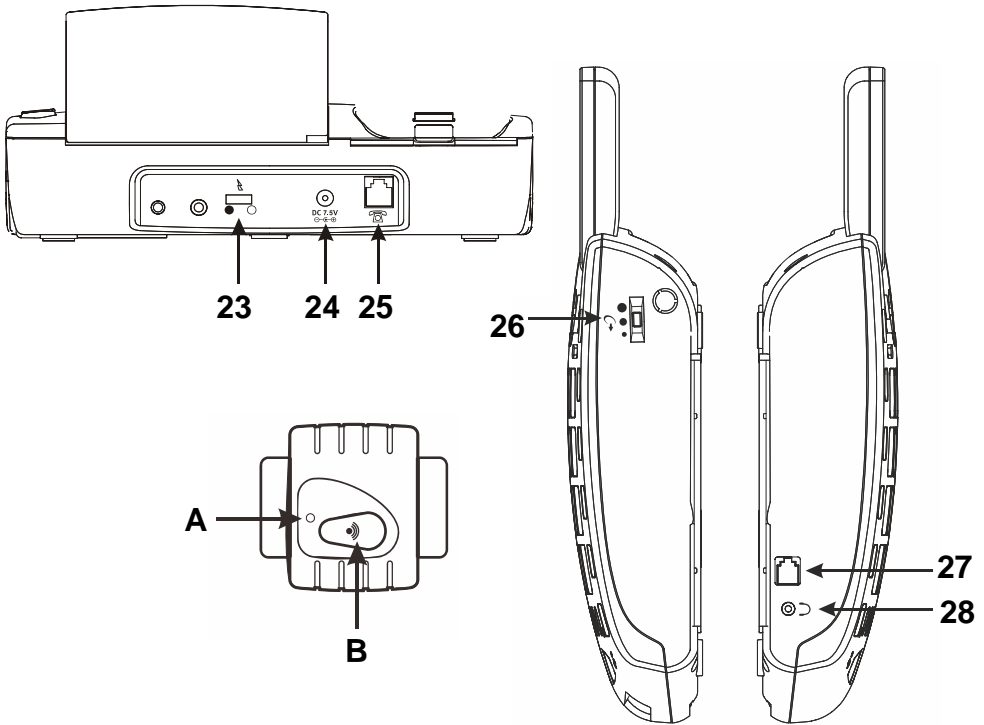





1. Hook Switch
2. Large LCD Screen
3. Left Soft Key
4. Up/Down Scroll
5. Right Soft Key
6. Tone reception Adjustment
7. Volume reception adjustment
8. Direct memory (**M1~M5**)
9. Mute Key
10. SOS Key
11. Headset Key
12. Volume Up Key
13. Speaker Key
14. Message waiting/new call LED
15. Volume Down Key
16. Redial Key
17. R Key
18. Pause Key
19. Speaker
20. Missed calls LED On/Off switch
21. Remote register button
22. Microphone



- 23. Strobe select mode
- 24. Power jack
- 25. Phone line cord jack
- 26. Speech Volume controls
- 27. Handset cord jack
- 28. Headset jack

A -> Remote Indicator
(Each time you press the button on the unit, the indicator lights in red.)
B -> SOS button
(This button are used to register the remote control to the base.)

Keys Description

	<p>Make/Answer/End a call.</p> <p>Activates the speakerphone if pressed during a call, as described in page 16.</p>
	<p>Last number redial, as described in page 13.</p>
	<p>Highlight or scroll through the menu options.</p> <p>Enter the CID list, as described in page 20.</p>
	<p>Perform the functions indicated by the text immediately over it (on the bottom line of the display) which changes time by time.</p>
	<p>Press this key during a call to mute the microphone temporarily.</p>
	<p>The five keys are used as one-touch speed dial keys.</p>
	<p>Insert a pause when pre-dialing a number.</p>
	<p>This key is used to disconnect a call and reestablish dial tone or to switch over to another caller if you use custom calling services such as call waiting.</p>
	<p>This key is used for emergency speed dialling.</p>

LCD description

In standby mode, the large LCD display will show as below :

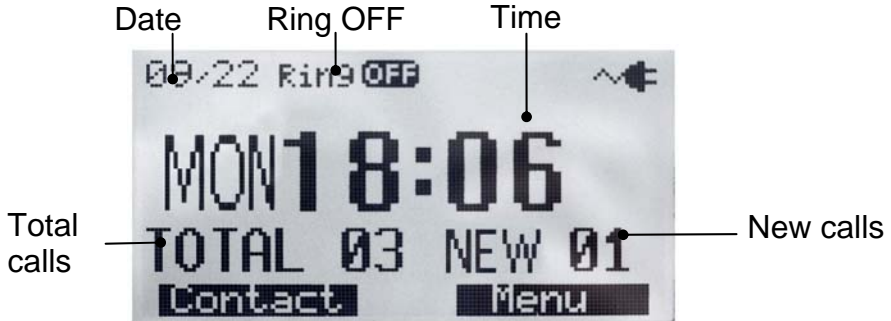

If you forget to connect the phone line cord, "No line" will show on the screen.

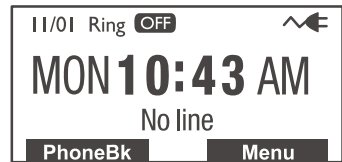

When you press the **Menu** soft key, the display will show the main menu. Use  keys to scroll through the menu and select the desired one, then press **Select** soft key to confirm.

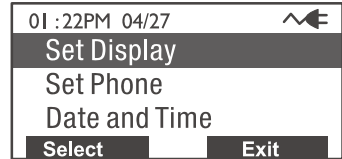

When a new call comes in, the screen will display the caller's phone number and/or name.

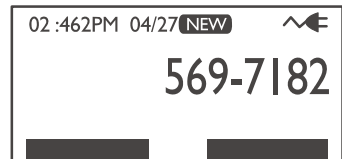

This shows you the total and new calls to be reviewed. In this example, you have 16 calls in total which includes 12 new calls.



Prior To Use

If the caller has exercised the option to prevent his name and number from being sent, "**Blocked number**" will be shown on the display.



This message will display when someone calls from an area where the telephone company is not offering the caller identification services or is not yet providing number delivery to your area.

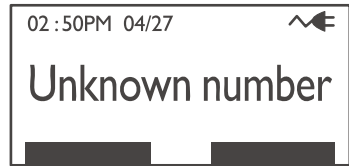

Night Light Function

If you move the **BACK LIGHT** switch located on the back of the LCD screen to  (**ON**) position, the LCD back light will be always bright so your phone can also be used as a night light.

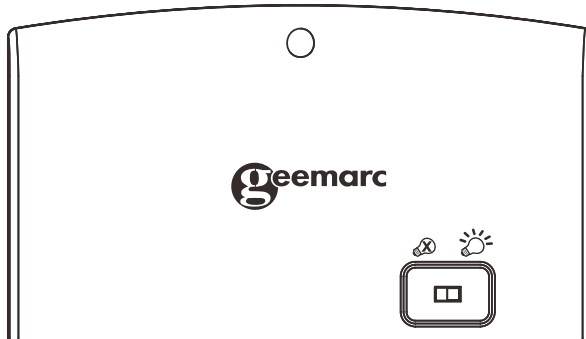

Wall Mounting

1. Slide the handset hanger tab out and reverse its position (rotate it 180 degrees). Slide it back into place so that the hook points up (see **diagram 1**). This will keep the handset from falling out of the cradle when it is mounted on the wall.
2. Install two self-tapping screws (not supplied) at a distance of 80 mm from each other and located on a vertical line.
3. Place the phone onto the screw-heads and slide down to secure (see **diagram 2**).

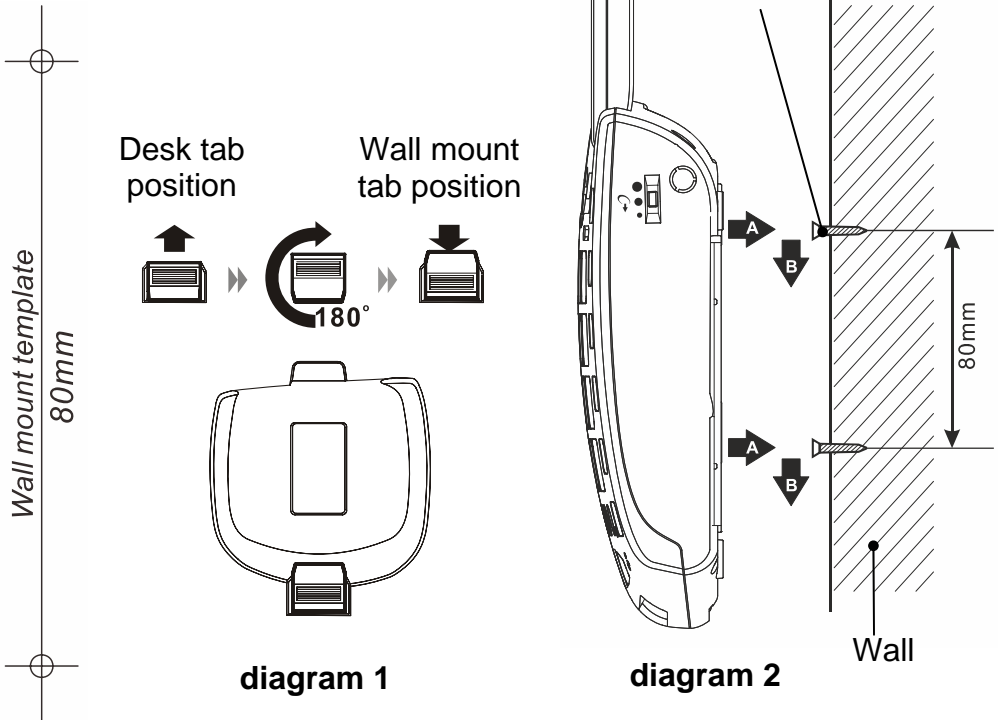

Basic Functions

Making a Call

1. To make a call, lift the handset, listen for a dial tone and adjust your volume & tone settings (see page 15).
2. You can dial a number manually or press one of the memory dial buttons. Please refer to page 18.
3. To end the call, replace the handset on the base.

You can enter the desired phone number in standby mode, which allows you to make corrections before dialing. Follow these steps:



1. Enter a telephone number (up to 32 digits). Check it. If you make a mistake while entering a number, press the **Clear** soft key to edit it.
2. When the number appears correctly, lift the handset or press the  key.

Last Number Redial

The  key is used to quickly redial the last number you dialed.



1. Lift the handset to get a dial tone.
2. Press the  key. The phone will redial up to 32 digits automatically.

Dialing a Number from the Redial List

1. Press the  key in standby mode.
2. Press  keys repeatedly until you find out the number you want to dial.
3. Pick up the handset or press the  key to dial out the number.

Use Redial Book options

Using the redial book options, you can add a number to phone book or delete a number in the redial book

1. Press the  key in standby mode.
2. Scroll to the desired number by using the  keys.
3. When the number appears on the display, press the **Options** soft key to choose the desired option:
 - **Erase:** allows you to delete the selected number.
 - **Erase all:** allows you to delete the whole redial book.
 - **Store:** allows you to add the number to the phone book. Enter a name you want to use with this number, then press the **Save** soft key.
4. To exit, press the **Back** soft key.

Receiving a Call

When a new call is received the phone will ring and the Visual ring indicator will flash.

1. To answer a call, lift the handset and speak.
2. Adjust your volume & tone settings if needed ([see page 15](#)).
3. To end the call, replace the handset on the base.



Muting the Microphone

During a conversation, you can temporarily switch your phone's microphone off, so that the other party cannot hear you.

To mute your microphone, press the  key during the conversation. The "Mute" appears on the LCD.

To unmute your microphone, press the  key. You will restore the normal condition.

Using the Amplification Function

Your phone is equipped with a specialized amplification function designed to fit your needs. During a conversation you can adjust the controls on the front panel of the phone (see diagram). Adjust the  control and  control to fit the levels to your hearing requirements.

The handset receiver volume adjustment is 0-30dB. The **TONE** control allows you to either boost low or high frequency range.

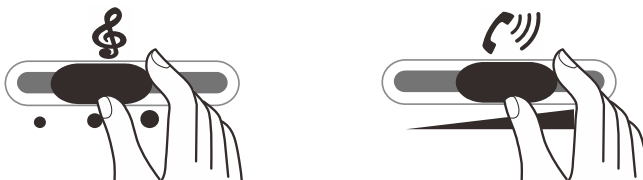

CAUTION: This telephone can produce very high (loud) sound levels. Repeated incremental exposure to amplification levels greater than 18 dB may be harmful to people without hearing loss. Always adjust the volume control to the minimum setting after using the phone.

Using your Phone with hearing aids

Your phone can be used with hearing aids equipped with a telecoil (T-coil). Adjust your hearing aid "T-switch" to the "T" position. Make sure to hold the handset close to your hearing aid.



Using the Headset Jack

Your phone is equipped with a Headset jack, providing total flexibility and multi-functionality. The jack is amplified, allowing you to adjust both the tone and volume.

This jack can accommodate many hands-free headsets. Using this jack you can listen and speak through your hands-free headset.



Hands-free

During a call, you may turn on the speakerphone built in the phone. In this mode you can enjoy the comfort of the handsfree conversation.

To turn the feature on, press the  key during a call, then replace the handset on the base. The  icon appears on the LCD.

To turn the feature off, and keep on talking in normal mode, simply pick up the handset. The  icon will disappear.

Adjusting Speaker Volume

In speaker mode you can adjust the speaker volume by using the Volume Controls  or  located on the front panel of the phone.









Hold Function



During a call, you can press the **Hold** soft key to put a call on hold and the LCD will display "**Call on hold**". Hanging up the handset will not disconnect the call.

To continue the conversation, simply pick up the handset or press the **Unhold** soft key.

Ringer Setting

You can select your own base ringer tone and adjust the ringer volume. You can also adjust the volume to **"Ringer OFF"** in order to turn off the ringer.

1. Press **Menu** soft key to display the main menu list.
2. Press  key to move to **Set Phone** and then press **Select** soft key.
3. Press **Select** soft key to choose **Set Ring**. Press **Select** soft key again to choose **Ringer volume**. You can choose among **Ringer OFF**, **Ring LOW**, **Ringer MEDIUM** and **Ringer HIGH**. Every time you press the  or  key, the phone rings with the selected volume level.
4. Press the **Select** soft key to confirm.
5. Press the  key to set the **Ringer tone**, press the **Select** soft key.
6. Press the  or  key repeatedly to select the desired ringer tone. Each time you press the  or  key, the phone rings with the selected ringer tone.
7. Press **Save** soft key to confirm and return to the previous menu.

In standby mode You can also adjust the ringer volume by using the Volume Controls  or  on the right side of the base phone. The display will show the current level. For example: **Ringer LOW**.

WARNING : RING VOLUME IS VERY LOUD AND CAN DAMAGE YOUR HEARING. NEVER PUT YOUR EAR CLOSE TO THE RINGER.

One-touch Memory

Your phone allows you to program 5 frequently dialed numbers (M1~M5). Each memory key can store up to 24 digits.

Storing Memory Numbers

1. Use the keypad to enter the number you want to store. You can use the **Clear** soft key to edit the number.
2. Press and hold one of the Memory dial keys (**M1 ~ M5**), the display shows **Name**.
3. Enter the name your want to use with the number. You can use the **Clear** soft key to edit it.
4. Press the **Save** soft key to confirm.

Note:

Entering a new number in the same location will automatically erase the previous number.

Viewing and Dialling Memory Numbers

In standby mode press one of the Memory dial keys (**M1 ~ M5**), the display will show the corresponding number. Lift the handset or press the  key to dial it out.



Using the Options

1. In standby mode press one of the Memory dial keys (**M1 ~ M5**).
2. Press **Options** soft key to choose the desired option:
 - **Play Voice:** allows you to play the voice prompt of this entry. If you have recorded the name for this entry, the system will announce the name, otherwise it can only announce the number.

Basic Functions

- **Record Voice:** allows you to record the name for the selected entry.
- **Erase Voice:** allows you to delete the name you have recorded for the selected entry.
- **Edit:** allows you to edit the selected entry.
- **Erase:** allows you to delete the selected entry.

Notes:

- *If you record a voice prompt for an entry, an icon  will appear before the name of this entry.*
- *After editing the name, you need to press the  key to edit the number.*

Flash Signal

When the line is engaged, pressing the **R** key sends the flash signal. This key is used in conjunction with special services (e.g. call waiting) which can be available in your phone network. For further details please contact your network telephone company.

To use the said special services, just press the **R** key while the line is engaged.

Note:

- *This key only operates when your telephone has been installed for Tone mode (**Dialing Mode** menu must be set to **Tone** option).*

Caller ID



This telephone automatically displays an incoming caller's number / name along with the date and time of the call. It will record up to 30 calls of up to 15 digits and store the data into memory.

IMPORTANT: You must subscribe to Caller ID Service from your local telephone company to utilize this feature.

Viewing the Caller List



Use  or  key to scroll through entries. Records will be listed in the order they were received.

Dialing a Number from the Caller List

Use  or  key to scroll to the desired number. Then pick up the handset or press the  key to dial it out.

Basic Functions

Using the Caller List Options

1. Use  or  key to locate the desired record.
2. Press **Options** soft key to choose the desired option:
 - **Erase:** allows you to delete the selected entry.
 - **Erase all:** allows you to delete all the entries.
 - **Store:** allows you to add the entry to the phonebook.

Note:

- *If you select **Erase all**, a message "**Erase all?**" will ask you to confirm or not. Press **Yes** to confirm or **No** to cancel.*

Phone Book

The phonebook built in your phone allows you to store frequently used numbers so that you can easily make a call without having to remember or enter the phone number.

Character Map

To enter a specific alphanumeric character, press one or more times the relevant key for the required character according to the following table: once for the first character, twice for the second and so on.

Key	Characters in the displayed order				
0	0				
1	(spc)	_	*	,	1
2	Aa	Bb	Cc	(2
3	Dd	Ee	Ff)	3
4	Gg	Hh	li	#	4
5	Jj	Kk	Ll	/	5
6	Mm	Nn	Oo	'	6
7	Pp	Qq	Rr	Ss	7
8	Tt	Uu	Vv	?	8
9	Ww	Xx	Yy	Zz	9

Notes:

- *If you want to shift the case between upper and lower, while entering letters, press * the key.*
- *When entering the same letter twice or a different letter with the same key, wait for a few seconds for the cursor to move automatically and then select the next letter.*

Basic Functions



Adding the Phonebook Entries

1. Enter a phone number (up to 24 digits) while in standby mode and then press **Save** soft key.
2. The display shows "**Name**". Enter the name you want to use, then press **Save** soft key to confirm.

Notes:

- *If you make a mistake while entering a name or a number, use the **Clear** soft key to correct it. Each time you press this key, the last digit is deleted.*



Viewing the Phonebook Entries

1. Press the **PhoneBK** soft key in standby mode to enter the phonebook.
2. Press  or  key repeatedly until the desired entry is displayed.
3. Lift the handset or press the  Key to dial out this number.

Note:

- *If you have activated the Review Talking feature in advance, every time you press  or  key, the system will announce the number or name of the highlighted entry.*

Using the Phonebook Options

1. Press **PhoneBK** soft key to enter the phonebook.
2. Press  or  key repeatedly until the desired entry is highlighted, press **View** soft key to view the details.
3. Press **Options** soft key to choose the desired option :
 - **Play Voice:** allows you to play the voice prompt of this entry. If you have recorded the name for this entry, the system will announce the name, otherwise it can only announce the number.
 - **Record Voice:** allows you to record the name for the selected entry.
 - **Erase Voice:** allows you to delete the name you have recorded for the selected entry.
 - **Edit:** allows you to edit the selected entry.
 - **Erase:** allows you to delete the selected entry.



Note:

- *If you record a voice prompt for an entry, an icon  will appear before the name of this entry.*

Menu Functions

Menu Navigation

To access a menu option:

1. To display menu list, press the **Menu** soft key.
2. To scroll through menu options, press  or  key repeatedly.
3. To select a menu, press the **Select** soft key when the desired menu appears on the display.
4. Repeat if necessary.

To exit from any menu:

If you press the **Back** soft key or the **Exit** soft key, the phone returns to the previous screen.

Menu Map

Set Display

Set Language (see page [26](#))
Set Contrast (see page [26](#))
Dim: X--->x (see page [27](#))
Hour Format (see page [27](#))
Date Format (see page [27](#))

Set Phone

Set Ring (see page [28](#))
Call Waiting (see page [28](#))
Set Flash (see page [29](#))
Dialing Mode (see page [29](#))

Date and Time

(see page [30](#))

Set Talk

DIALING TALKING (see page [31](#))
CID TALKING (see page [31](#))
REVIEW TALKING (see page [32](#))
Voice Prompt (see page [32](#))

Set SOS



SOS NUMBER (see page [33](#))
SOS SOUND (see page [34](#))
Auto turn on (see page [35](#))
Security ID (see page [35](#))

Set Display



Using this feature, you can customize the display settings, according to your taste and needs (language, contrast, hour format and date format).

Language Setting (unavailable)

The phone supports up to 4 predefined languages: English, Spanish, French and German. You can change the language used to display the menu messages.





1. Press **Menu** soft key to display the main menu list.
2. Press **Select** soft key to access **Set Display**.
3. Press **Select** soft key to select **Set Language**.
4. Press  or  key repeatedly to scroll through the options. Each language will be displayed in its own native translation.
5. Press **Select** soft key to select the required language.

LCD Contrast Setting

1. Press **Menu** soft key to display the main menu list.
2. Press **Select** soft key to access **Set Display**.
3. Press the  key to move to **Set Contrast**, press **Select** soft key.
4. Press  or  key repeatedly to choose among the 8 available contrast levels and then press **Select** soft key.

Menu Functions





Switch to smaller font

1. Press **Menu** soft key to display the main menu list.
2. Press **Select** soft key to access **Set Display**.
3. Press  or  key repeatedly to move to **Dim:X--->x**, press **Select** soft key.
4. Press  or  key repeatedly to choose **ON** or **OFF** and then press **Select** soft key.

Note:

- If you select **ON**, when you pre-dial a number, if the number exceeds 8 digits, the font will be switched to smaller size automatically.





Hour Format Setting

1. Press **Menu** soft key to display the main menu list.
2. Press **Select** soft key to access **Set Display**.
3. Press  or  key repeatedly to move to **Hour Format**, press **Select** soft key.
4. Press  or  key repeatedly to choose **12 hour clock** or **24 hour clock** and then press **Select** soft key.

Note:





- If you select **12 hour clock**, **AM / PM** will appear on the right of the time in standby mode.

Date Format Setting





1. Press **Menu** soft key to display the main menu list.
2. Press **Select** soft key to access **Set Display**.
3. Press  or  key repeatedly to move to **Date Format**, press **Select** soft key.
4. Press  or  key repeatedly to choose **MM / DD** or **DD / MM** and then press **Select** soft key.

Set Phone

Keypad Tones Setting





1. Press **Menu** soft key to display the main menu list.
2. Press the  key to move to **Set Phone** and then press **Select** soft key.
3. Press **Select** soft key to access **Set Ring**.
4. Press the  or  key to choose **Keypad Tones**, then press **Select** soft key.
5. You can use  or  key to choose **ON** or **OFF** to enable or disable the function.
6. Press the **Select** soft key.

Call Waiting





1. Press **Menu** soft key to display the main menu list.
2. Press the  key to move to **Set Phone** and then press **Select** soft key.
3. Press the  key to move to **Call Waiting**, and then press **Select** soft key. The display shows the current setting.
4. Use  or  key to select **ON / OFF** to activate / deactivate the call waiting function, press **Select** soft key to confirm.

Menu Functions

Flash Time Setting

1. Press **Menu** soft key to display the main menu list.
2. Press the  key to move to **Set Phone** and then press **Select** soft key.
3. Press  or  key repeatedly to move to **Set Flash** and then press **Select** soft key. The display shows the current setting.
4. Press  or  key repeatedly to choose among **100ms**, **300ms** and **600ms**, press **Select** soft key.

Dialing Mode Setting





1. Press **Menu** soft key to display the main menu list.
2. Press the  key to move to **Set Phone** and then press **Select** soft key.
3. Press  or  key repeatedly to move to **Dialing Mode** and then press **Select** soft key. The display shows the current setting.
4. Press  or  key repeatedly to choose between **Tone** and **Pulse**, press **Select** soft key.

Note:

- *This menu is not used in countries where only Tone dialing is available.*
- *If you are not sure which dialing mode to select, please contact your local service provider.*

Setting Date & Time

In standby mode, the phone displays the current date and time to help you keep track of your appointments. You need to set the date and time so that when you receive calls they will appear with the correct date and time.

1. Press **Menu** soft key to display the main menu list.
2. Press the  or  key repeatedly to move to **Date and Time**, press **Select** soft key. The current settings are displayed.
3. Enter the current time using the numeric keypad, press **Save** soft key.
4. Enter the current date using the numeric keypad, press **Save** soft key.
5. Press  or  key repeatedly to select the correct week, press **Save** soft key.





Note:

- *You can select the hour format and date format. Please refer to par. **Hour Format Setting** and **Date Format Setting**.*
- *We have set 10 pm to 6 am as "night" and 6 am to 10 pm as "day".*

Set Talk





Dialing Talking

This feature allows you to check the number you have entered in standby mode without looking at the display.



1. Press **Menu** soft key to display the main menu list.
2. Press the  or  key repeatedly to move to **Set Talk**, press **Select** soft key.
3. Press **Select** soft key to access **DIALING TALKING**.
4. Use the  or  key to select **ON / OFF** to activate / deactivate the dialing talking function, press **Select** soft key to confirm.







CID Talking

The talking CID can announce the number that comes in unless the caller blocks the number, so this feature allows you to check the caller ID number or caller's name when a new call is receiving without looking at the display. Note that if you have stored a number in phone book and recorded the corresponding name, when an incoming call with this number comes in, the system will announce the name associates with this number.

1. Press **Menu** soft key to display the main menu list.
2. Press the  or  key repeatedly to move to **Set Talk**, press **Select** soft key.
3. Press the  key to move to **CID TALKING**, press **Select** soft key.
4. Use the  or  key to select **ON / OFF** to activate / deactivate the CID talking function, press **Select** soft key to confirm.







Review Talking

The system can announce the number that stored in phone book when you are reviewing the phone book, so the feature allows you to check these numbers when you use  or  key to scroll through the phone book entries. Note that if you have recorded the corresponding name, the system will announce the name associates with this number. To activate this feature, do the following steps:

1. Press **Menu** soft key to display the main menu list.
2. Press  or  key repeatedly to move to **Set Talk**, press **Select** soft key.
3. Press  or  key repeatedly to move to **REVIEW TALKING**, press **Select** soft key.
4. Use the  or  key to select **ON / OFF** to activate / deactivate the CID talking function, press **Select** soft key to confirm.

Voice Prompt

You are able to select the language used to play the voice prompt messages.

1. Press **Menu** soft key to display the main menu list.
2. Press  or  key repeatedly to move to **Set Talk**, press **Select** soft key.
3. Press  or  key repeatedly to move to **Voice Prompt**, press **Select** soft key.
4. Use the  or  key to scroll through the options. Each languages will be displayed in its own native translation.
5. Press the **Select** soft key to choose the required language.

SOS Setting

Accessing the SOS function, you can ask for help by onetouch operation when you are in emergency or pay attention to everything happens at home by remote control whenever.

Note: You need to connect the adaptor for the SOS function.

To ask for help by one-touch operation





To use the function of asking for help by one-touch operation, you need to preset the SOS number and you'd better record a message that you want to tell the helper.

Registration

The remote control unit is already registered to the base. When you cannot use the remote control to dial SOS numbers, do the following operations.





Press the Remote register button located on the right side of the base, then press the  button on the remote control unit.

Storing SOS Numbers

1. Press **Menu** soft key.
2. Press the  or  key repeatedly to move to **SET SOS**, press **Select** soft key.
3. Press **Select** soft key to choose **SOS NUMBER**.
4. The phone provide 5 SOS number memory locations (0~4) for setting. Press the  or  key to select one location, press **Select** soft key.
5. Enter the telephone number by numeric keypad (16 digits maximum for each memory). You can press the **Clear** soft key to delete the previous digit if necessary.
6. Press the **Save** soft key to store it.

Recording SOS Message



You can use your phone to record SOS messages (up to 8 seconds).

1. Press **Menu** soft key.
2. Press  or  key repeatedly to move to **SET SOS**, press **Select** soft key.
3. Press the  key to choose **SOS SOUND**, press **Select** soft key.
4. Press the  key to select **RECORD SOUND** and press **Select** soft key to confirm. You can record a message within 10 seconds.

Note:

- *In the message, you should tell the helper to press one of the special buttons (0~9, *, #) to confirm that your SOS message has been received.*
- *If you want to record a message for less than 10 seconds, you can press the End soft key to confirm and exit.*

Playing SOS Message







1. Press **Menu** soft key.
2. Press  or  key repeatedly to move to **SET SOS**, press **Select** soft key.
3. Press the  key to choose **SOS SOUND**, press **Select** soft key.
4. Press **Select** soft key to choose **PLAY SOUND**. You can press the **End** soft key to stop during the playing.

Menu Functions





SOS Emergency Dialing

After setting the SOS number and message, you can use the SOS function conveniently. Press the **Emergency** key on the base phone to dial 5 SOS numbers one by one until the line gets through and someone responds. The telephone will dial the first SOS number. If there is no response in 30 seconds or the line is busy, the telephone will dial the second SOS number. If there is still no response in 30 seconds or the line is still busy, the telephone will dial the next number in turn until all the numbers you set are Each time you dialled three times.

Auto Turn On

1. Press **Menu** soft key.
2. Press  or  key repeatedly to move to **SET SOS**, press **Select** soft key.
3. Press  or  key to choose **Auto turn on**, press **Select** soft key.
4. Press  or  key to choose **ON** or **OFF**, press **Select** soft key.

Security ID

1. Press **Menu** soft key.
2. Press  or  key repeatedly to move to **SET SOS**, press **Select** soft key.
3. Press  or  key to choose **Security ID**, press **Select** soft key.
4. The display shows the current security ID. Enter the new one you want to use, press **Save** soft key.

After turn on " Auto turn on " and set the Pin code, you can use the function as follows.

After 10 times ringing is detected, the phone will be auto offhook the line (In this state, the user can hear the caller but cannot answer the call), and then generates two "bip-bip" tones to remind the caller to enter Pin code to enter full speaker state. The caller enters the Pin code, and then starts the conversation. Every 2 minutes later, the caller will hear a prompt tone. Then the caller need to press any button to continue the conversation. Otherwise, the line will be disconnected automatically.

NOTE: *When the phone is auto off-hook the line, the user can press the  key to enter full speaker state. In this way, there is no need for caller to enter Pin code.*

Caller ID on Call Waiting

When you subscribe to Call Waiting service from your local telephone company and activate the Call Waiting function via menu, the telephone will display the name and number of the second caller while you are having a conversation.

Caller ID info displayed

Caller 1
436-1234

Caller two's information
is displayed

Caller 1
436-1234
Caller 2
291-5678

1. When you are on the line, the telephone will automatically display the name and number of the second caller.
2. Press the **R** key to answer the second caller.
3. When you have finished, press the **R** key to continue with your conversation with the first caller.

- FSK and DTMF dual system Caller ID
- Extra Large Caller ID Screen
- Caller ID list with up to 20 entries
- Caller ID/Call Waiting
- Phonebook with up to 30 entries
- Amplification function
- Amplified Headset jack
- Hearing Aid compatible
- Adjustable volume control
- Adjustable extra-loud ringer
- Big Keypad buttons
- Real time clock with date & time
- Flash, Mute, Hold
- 5 one-touch speed dial keys
- LCD contrast setting
- Hour & Date format setting
- Hands-free speakerphone
- Dialing mode selection
- Wall mounting
- Dialing talking & CID talking
- 5 SOS numbers auto-dialing
- SOS message recording.

Troubleshooting

No dial tone

1. Check that all phone cord connections are securely plugged into the telephone & wall jack.
2. Check that the phone is in the correct dialing mode, tone or pulse.
3. Plug another phone into the wall jack to make sure your phone service is working properly.

No audible ringer

1. Make sure the ringer is not turned off.
2. Check the volume level of the ringer.
3. You may have too many extensions on your line. Try unplugging a few devices.

No amplification

1. Check to see if the Amplify key is "On". The red light should be lit.

Noise, Static, Interference while using the handset

1. A filter may be required for homes with a DSL line or near Radio towers.

Caller ID information does not show

1. Make sure you are subscribed to Caller ID through your local company.

SAFETY INFORMATION

General

Only use the power supply included with the product.

Do not open the unit. Contact the helpline for all repairs.

Cleaning

Clean the telephone with a soft cloth. Never use polishes or cleaning agents - they could damage the finish or the electrics inside.

Environmental

Do not expose to direct sunlight.

Always ensure there is a free flow of air over the surfaces of the telephone.

Do not place any part of your product in water and do not use it in damp or humid conditions e.g. bathrooms.

Do not expose your product to fire or other hazardous conditions.

Unplug your phone from the telephone socket during thunderstorms because it could damage your telephone. Your guarantee does not cover thunderstorm damage.

The telephone is designed for working within a temperature range of 5oC to 45oC.

GUARANTEE

From the moment your Geemarc product is purchased, Geemarc guarantee it for the period of one year. During this time, all repairs or replacements (at our discretion) are free of charge. Should you experience a problem then contact our help line or visit our website at www.geemarc.com. The guarantee does not cover accidents, negligence or breakages to any parts. The product must not be tampered with or taken apart by anyone who is not an authorized Geemarc representative. The Geemarc guarantee in no way limits your legal rights.

IMPORTANT: YOUR RECEIPT IS PART OF YOUR GUARANTEE AND MUST BE RETAINED AND PRODUCED IN THE EVENT OF A WARRANTY CLAIM.

Please note: The guarantee applies to the United Kingdom only

DECLARATION: Geemarc Telecom SA hereby declares that this product is in compliance with the essential requirements and other relevant provisions of the Radio and Telecommunications Terminal Equipment Directive 1999/5/EEC and in particular article 3 section 1a, 1b and section 2.

The telephone does not operate if the line current is lower than 18 mA.

The declaration of conformity may be consulted at www.geemarc.com.



Electrical connection: The apparatus is designed to operate from a 230V 50Hz supply only. (Classified as 'hazardous voltage' according to EN60950 standard). The apparatus does not incorporate an integral power on/off switch. To disconnect the power, either switch off supply at the mains power socket or unplug the AC adaptor. When installing the apparatus, ensure that the mains power socket is readily accessible.

Telephone connection: Voltages present on the telecommunication network are classified TNV-3 (Telecommunication Network Voltage) according to the EN60950 standard.

RECYCLING DIRECTIVES

The WEEE (Waste Electrical and Electronic Equipment) has been put in place for the products at the end of their useful life are recycled in the best way.

When this product is finished with, please do not put it in your domestic waste bin.

Please use one of the following disposal options:

- Deposit the product in an appropriate WEEE skip.
- Or, hand the old product to the retailer. If you purchase a new one, they should accept it.

Thus if you respect these instructions you ensure human health and environmental protection.



For product support and help visit our website at

www.geemarc.com

Telephone **01707 384438**

Or fax **01707 832529**



UGSERENITIES_En_V0.1

geemarc™ UNITED KINGDOM
Telecom SA

5 Swallow Court
Welwyn Garden City Swallowfields
Hertfordshire, AL7 1SB
For product support:
01707 384438
www.geemarc.com